

TECHNICAL DRAWING / DESSIN TECHNIQUE

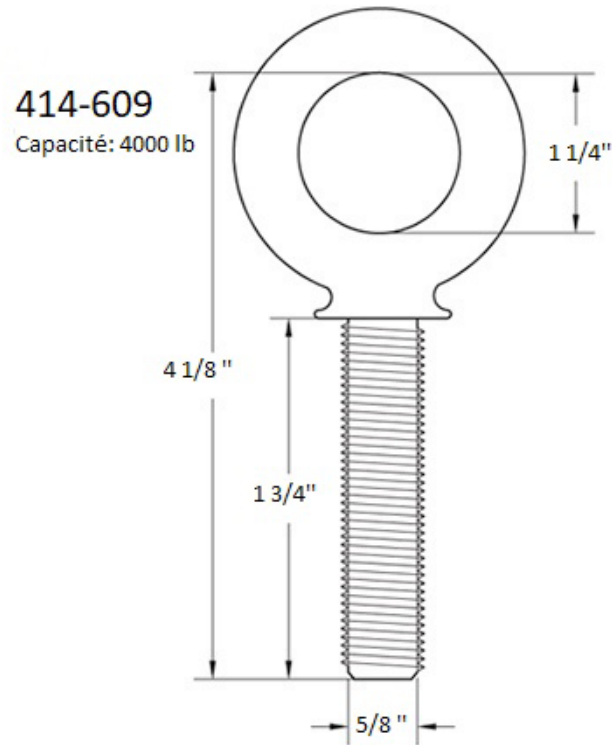

JIMEXS
HARDWARE

1 866 447-5656 / INFO@JIMEXS.COM

WWW.JIMEXS-HARDWARE.COM

414-609

Boulons à oeil - Type machinerie
Shoulder type machinery eye bolt

2022-02-08

PROJECTIONS



DIMENSIONS

5/8" x 1-3/4" - Eye 1-1/4"

MATERIAL / MATÉRIEL

Acier forgé - plaqué zinc /

Drop forged steel - zinc plated

SPECS

ABS : 4000 lbs